



DeLaRue

user guide

1600

Currency counting machines

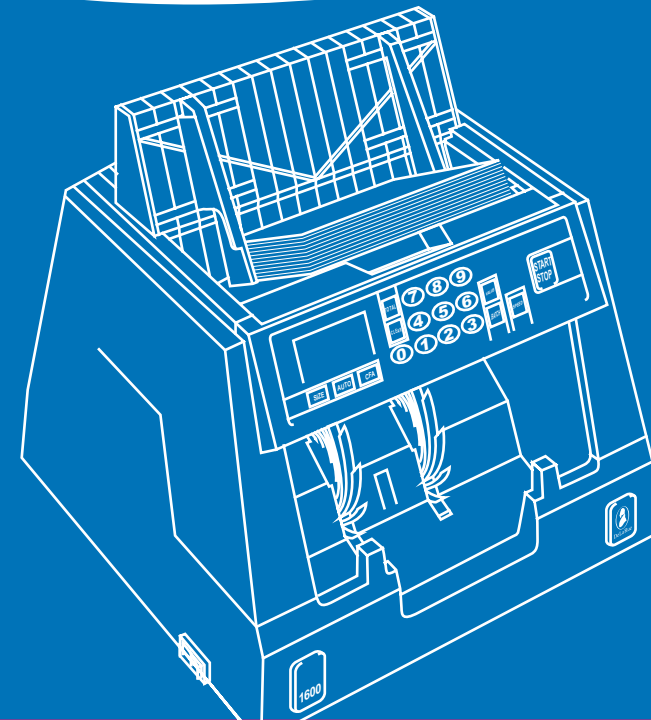

DeLaRue

**DE LA RUE
CASH SYSTEMS**

Walton Rd, Farlington,
Portsmouth Hampshire
P06 1TJ

Tel: +44 (0) 2392 383161
Fax: +44 (0) 2392 325822

REFERENCE- TML409

De La Rue Systems Limited is pleased to give detailed specifications of its products in this leaflet but expressly reserves the right to vary these at its discretion at any time without notice. As the Company's products and services are continuously being developed it is important for customers to check that the information contained herein includes the latest particulars. This leaflet is for general guidance only and may contain inappropriate information under particular conditions of use. All recommendations and suggestions issued by or on behalf of the Company in whatever form, are subject to the Company's terms and conditions of sale, of which a copy will be supplied on request. This document is not part of a contract or licence, save insofar as may be expressly agreed.

© De La Rue Systems Limited 2002

All items of technical information, advice, know-how, drawings, designs, specifications and other items communicated in this document are confidential and remain the property of De La Rue Systems Limited and shall not be disclosed to a third party without written consent of De La Rue Systems Limited.

The above duty of confidence also entails a prohibition of reproduction of this text without specific authority, in writing, from De La Rue Systems Limited.

Safety information	2
Introduction	
Overview of machine	3
Controls	4
Display	4
Setting up	5
Basic operating functions	
Speed	7
Batch mode	8
Count mode	10
Advanced functions	
Value modes	12
Supervisor functions	
Machine configuration	15
Speed	16
Batch	16
Stacker limit	18
Data recovery	18
Information	
Factory Settings	19
Display messages	20
Maintenance	
Specification	21
Routine maintenance	22

routine maintenance

The sensors in the machine can fail if they are obscured by dirt.

Switch the machine off.

Using a dry cloth, clean the hopper, stacker and track sensors (1, 2 and 3).

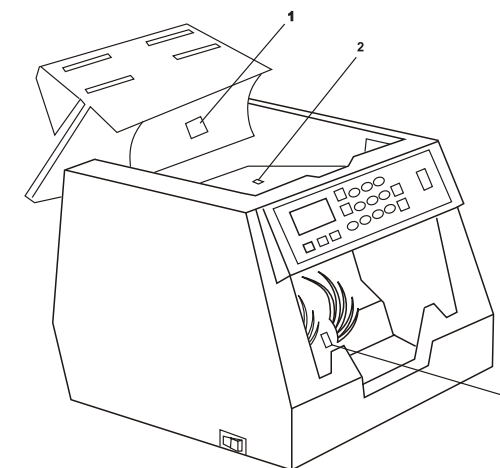
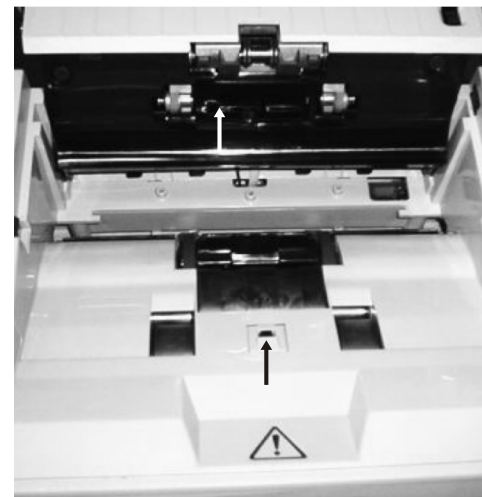

specification

Mains voltage	Nominally 98v - 264v AC, 50/60Hz
Power consumption	150W max at 1500 npm
Acoustic noise level	<81dBA at 1500 npm
Dimensions	
Height	190mm
Width	285mm
Depth	250mm
Weight	6kg
Document size range	190x190mm maximum 100x50mm minimum
Throughput speed	600-1500 notes per minute variable
Hopper capacity	500 notes
Stacker capacity	200 notes



Declaration of conformity

Manufacturer & responsible person
De La Rue

Details of product
Currency counter

Model types
1600

This product conforms to the essential requirements of:

Electromagnetic compatibility

Directive 89/336/EEC
Amended by 92/31/EEC

Low voltage electrical equipment (safety)

Directive 73/23/EEC
Amended by 93/68/EEC

and is supported by the following applicable standards

EN 55 022	EN 292-1
EN 50 082-1	EN 292-2
EN 60 950	EN 1050
EN 29001 (ISO 9001)	

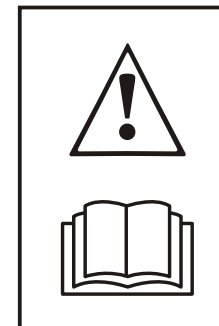

Warning

This machine has been designed for optimum safety for users. For your added protection please follow these guidelines.

Voltages above 42V are potentially dangerous.

Always handle mains-supplied equipment with caution.

Never open the machine when it is plugged in.

If the sensors are obscured the feed rollers will operate.

Always keep loose clothing and hair out of the feed hopper area when operating the machine.

overview of machine

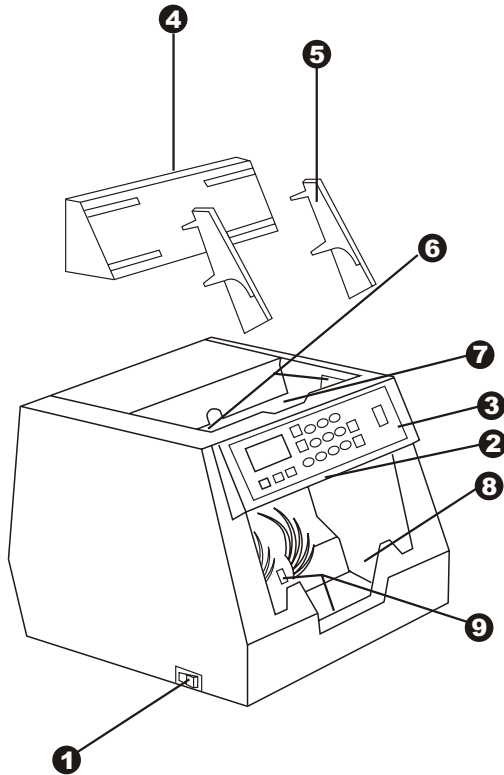

- 1 On/off switch**
- 2 Lifting point** hold under centre of control panel
- 3 Control panel**
- 4 Note guide support** } aligns notes to be counted
- 5 Note guides**
- 6 Release buttons** for service/jam clearance/cleaning access
- 7 Hopper** notes are placed here for counting
- 8 Stacker** counted notes are collected here
- 9 Stacker sensor** for detecting counted notes

The 1600 is an accurate, high speed, automatic currency counting machines, it has been designed to incorporate many useful features and to be easy, safe and reliable to use and maintain.



display messages

display	reason	solution
CLEAR	Sensors in hopper, stacker and/or track sensor obscured by notes or dirt.	Remove notes and/or clean the sensors.
FEED	Notes jammed in hopper, stuck together or too thick for note thickness setting.	Remove notes from hopper. Ensure that they are unstuck before refeeding. Alter note thickness setting if necessary (see setting up instructions).
HALF	A half note has been detected by the machine.	Remove notes from stacker. Remove suspect note(s) from bundle and repeat the count. When the notes are re-fed, the count display returns to 0 or displays the total when the stacker was last emptied. Press START to continue.
JA	Notes are jammed in the machine transport.	Switch machine off. Open machine by pressing release buttons as shown on page 3. Remove notes carefully. Close machine. Switch machine on.
rFEED	The machine has stopped as a result of a note handling problem.	Remove all notes from stacker and repeat the count.
CHEC	This machine has stopped as a result of a badly damaged or degraded note.	Remove all notes from the stacker, remove damaged notes and repeat count.
LAST	A note from the previous bundle is left in the transport.	Remove note and recommence count.
OLP	3 or more notes have passed through the machine together.	Remove all notes from stacker. Remove suspect notes from bundle and repeat the count.
OVER	Only appears in value mode and shows that a higher value than originally requested has been dispensed.	Replace notes with lower value in hopper.
FAULT	A fault has been detected in the machine.	Switch off the machine and contact your agent's service engineer.

factory settings

1600

The following list shows the factory settings of the machine configuration, to which the machine is set at power up.

Stacker hopper limit	100 notes
Value mode	Value off
Speed table default	1500 notes per minute
Speed table settings	1500, 1200, 1000, 600
Batch size table default	100
Batch size table settings	100, 50, 25, 20, 10, 5
Feed gap adjuster arm setting	position 4

1600 controls

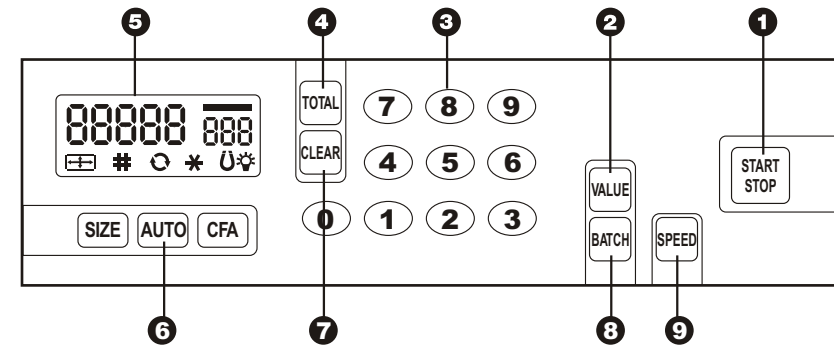

- 1 Start/stop
- 2 Value press to select batch/count.
value count or value dispense mode
- 3 Numeric keypad
- 4 Total displays total of notes counted
- 5 Display
- 6 Auto enables/disables automatic start
- 7 Clear clears display
- 8 Batch set batch size, press to step through pre-set batch sizes
- 9 Speed set throughput speed, press to step through pre-set speeds

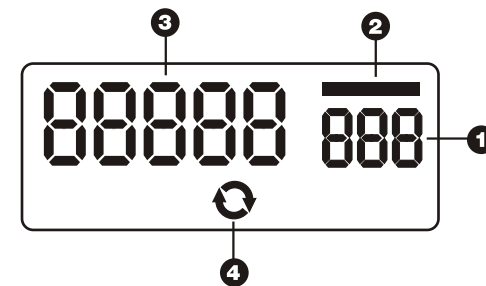

- 1 Batch display displays the batch quantity (*000* for count mode)
- 2 Bar visible in count & batch mode, invisible in value mode
- 3 Count display displays the count
- 4 Autostart visible if autostart is on

setting up

1

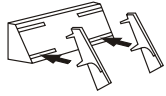

Attach the note guides to the note guide support.

2

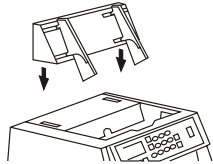

Clip the note guide support to the top of the machine.

3

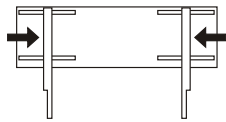

Notes must be positioned centrally, adjust the note guides to the length of the notes to be counted allowing adequate clearance for notes to move freely.

4

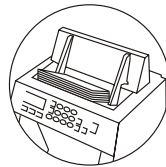

Notes to be counted should be placed in the hopper. They should be laid flat and stacked neatly together.

4a

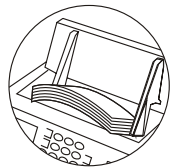

bowed notes

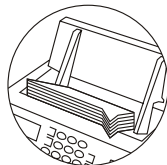

cornerfolded notes

When counting damaged or deformed notes, the following guidelines should be observed for optimum performance.

Place bowed notes with edges pointing down onto hopper.

Cornerfolded notes should be sorted with the folds in the bottom right hand corner and the bundle placed face down onto the hopper.

data recovery

recovery from power failure

In this mode count data and the basic operating mode can be stored during the period the machine is switched off. This gives the opportunity to recover data after a power failure.

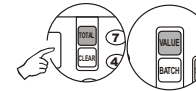

on rEC

Press and hold **TOTAL** and **VALUE** to enter this function, the current mode is displayed.

Press the **BATCH** key to step through the modes available.



on rEC - automatically restore data and count mode in operation prior to the power failure.

Auto rEC - automatically restore data and count mode only if the power failure was during a count run.

rEStr rEC - restores from memory the last successful count data stored.

To select a mode, press the **START** key, when the desired mode is displayed.



donE rEC

Press **TOTAL** to exit supervisor mode.



stacker limit

stacker limit



100 -b-

In this mode you can set the stacker limit. This is the maximum number of notes that the machine will allow to be counted before the stacker needs emptying.

Press and hold **TOTAL** and **6** to enter this mode.

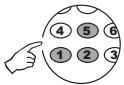

125 -b-

The count display will show the current stack limit. The limit can be changed within the range of 50 - 200 by pressing the numeric keys.



To exit this mode press the **TOTAL** key.

setting up

5

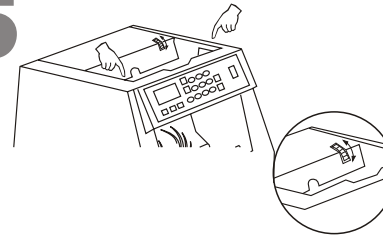

note thickness adjuster

Depending on the thickness and quality of notes being counted, you can adjust the feedgap where the notes enter the machine. The control has six positions. Turn off the mains switch, open the top of the machine by releasing the blue buttons together as shown.

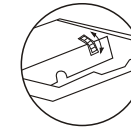

Turning the control down narrows the feedgap for thin and poor quality notes. Turning up widens the feedgap for thick notes.

Close the lid carefully and ensure both blue buttons are secured.

Guide to setting your banknote counter

To achieve optimum performance for your application, it is necessary to set up the note counter prior to use.

The machine must be switched OFF prior to setting.

- 1 Open the feedgap control by turning it upwards to the smallest setting.

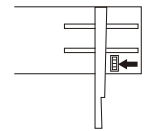

- 2 Turning the rubber roller until the ridged portion is uppermost.

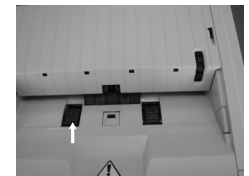

- 3 Adjust the feedgap control downwards one click at a time, until some resistance is felt when the ridged portion of the rubber roller is moved gently backwards and forwards by hand.



- 4 Now adjust the feedgap control upwards two clicks (or one whole position on the indicator).

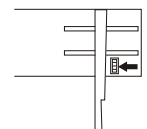

speed

- 5 The counter is now ready to used. Switch the machine on.

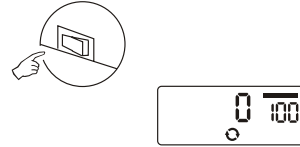

- 6 Set the batch size to 100 by pressing the **BATCH** key until 100 appears on the display. Place a pack of notes on the hopper and press **START**. The machine will start to count.



If the machine hesitates when feeding notes or shows any other problems, adjust the feedgap to one click either side of the chosen position.

The note counter is now set to achieve optimum count performance.

switching on

Connect the mains lead to the socket on the rear panel of the machine.

Plug the machine's power lead into a mains socket and switch on the mains supply.

Switch on the machine's on/off switch.

The machine will power up and complete a self test routine. The display will select a batch size of 100 notes and the autostart function will be activated.

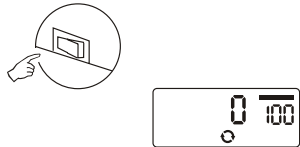

You may want to reduce the speed, for example, when counting very poor quality notes.

Select the throughput speed by pressing the **SPEED** key.

Press this key repeatedly to step through the speeds that have been preset e.g. 1500, 1200, 1000, 600,

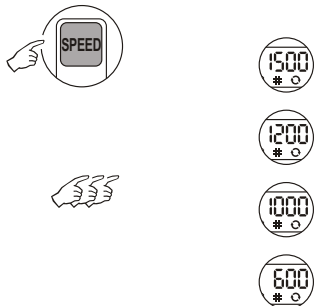

speed & batch

speed



In this mode you can change the table of throughput speeds.

Press and hold **TOTAL** and **SPEED** to enter this mode.

Select the speed you require to change by pressing the **SPEED** key repeatedly.

Input the speed you require by pressing the numeric keys and press **START**.

Four speeds can be set in the range 600 to 1500, and are sorted in descending order.

To end this mode press the **TOTAL** key.

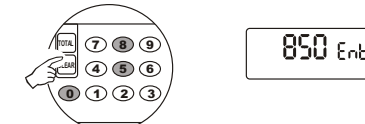

batch

In this mode you can reset the table of batch sizes.

Press and hold **TOTAL** and **BATCH** to enter this mode.

Select the batch size you require to change by pressing the **BATCH** key repeatedly.

Select the batch size you require by pressing the numeric keys and press **START**.

Six batch sizes can be set in the range 1 to 999, and are sorted in descending order.

To exit this mode press the **TOTAL** key.

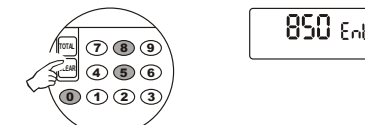

machine configuration

A range of operations is provided to enable you to alter the parameters of the machine. To enter these functions press and hold **TOTAL** and then press the key corresponding to the function you wish to change. These include machine configuration, speed, batch sizes, size operations, UV detection level, and stacker limit .

machine configuration

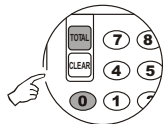

This operation allows you to save your own set up configuration of the machine in the memory, e.g. batch sizes, speed etc or to reset to the configuration held in the memory, or to reset to the factory defaults.



Press **TOTAL** and **0** to enter this mode.

Use the **BATCH** key to step through the functions.



This saves the current machine setup in the memory. The machine will set itself to this configuration each time it is switched on.

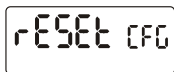

This resets the machine to the configuration previously stored in the memory.



This sets up the machine to the factory default configuration. It will not change the machine set up that you have stored in the memory.



When you have chosen the required option, press the **START** key.



To exit this mode press the **TOTAL** key.

batch mode



The 1600 is in batch/count mode if the display shows Cnt when the value key is pressed.

1



or

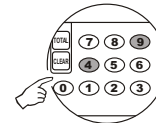

Select the batch size to be counted by pressing the **BATCH** key.

Use this key to step through the quantities that have been pre-set e.g. 100, 50, 25, 20, 10, 5 (and 000 which is the count mode).

On the 1600 batch size can be set from 1 to 999 using the keypad.

2

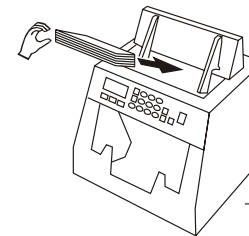

Place the notes to be counted onto the feed hopper.



or

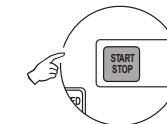

The machine will automatically start, with **AUTO** selected, or

you can choose to start it manually by pressing the **START** key. if auto is deselected.



The machine will stop when the batch size has been reached.

batch mode

3

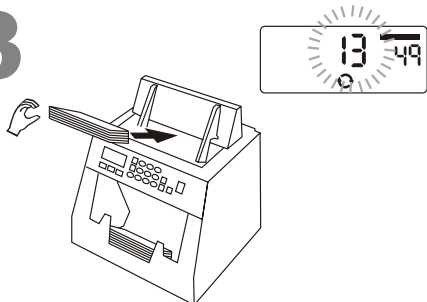

If there are not enough notes in the feed hopper to complete a batch, the total counted will flash on the count display to indicate this. Without removing the notes in the stacker, add more notes to the feed hopper and the machine will continue to count.

4

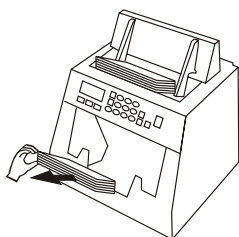

Remove the notes from the stacker.

If the machine stops because of a 'degraded note' a rFEED or ChEC message will be displayed, rFEED indicates that the whole bundle should be fed again. If ChEC is displayed remove notes from the stacker and return only undamaged notes to the feeder.

If **AUTO** is selected, press **START** to clear the error message, the machine will restart automatically.

If **AUTO** is not selected, press **START** to clear the error message and press **START** to continue the count.



The next batch will be started automatically if there are notes in the feed hopper and autostart is selected.

totals

1



Every time a batch is completed correctly, it is added to a running total.

To show the total number of notes counted in complete batches, press the **TOTAL** key.

2

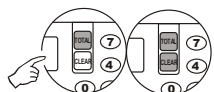

To clear the running total, hold down the **TOTAL** key and press **CLEAR**.

1600 value mode

dispense...

4



Press the **START** key.

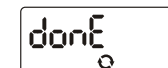

If the dispense amount has been completed successfully the display will show **DONE**.



If the dispense amount cannot be completed successfully because there are not enough notes on the hopper the display will flash the remaining value it needs.



If the dispense amount cannot be completed successfully because the denomination set is larger than the remaining value required, the display will show **NEAR**.

Place a new denomination in the hopper, press **START**, and input the new denomination to complete the dispense.



Remove the notes or press **CLEAR** to revert back to the dispense amount.

1600 value mode

3

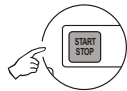

Press the **START** key.

With **AUTO** selected the machine will continue to count each bundle at the denomination set, adding the value of each batch to a running total.

If **AUTO** is not selected the denomination may be changed for each new batch. The display will show the total value counted.



To clear the running total and to start to count a new denomination press **TOTAL** and **CLEAR** together.

dispense

1

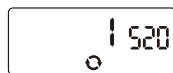

Key in the value to be dispensed.

2

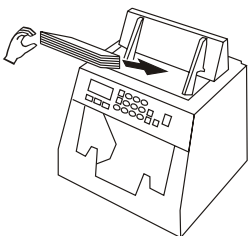

Place notes to be dispensed in the hopper.

3



Key in the denomination of the notes to be dispensed.

count mode



The 1600 is in batch/count mode if the display shows Cnt when the value key is pressed.

The machine will count notes continuously, pausing only when the stacker is full.

1

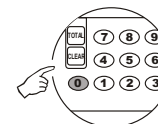

Set the batch size to **000** using the numeric keypad. The display will change to 000

or



Select count mode by pressing the **BATCH** key to step through the pre-set quantities until you reach 000

2

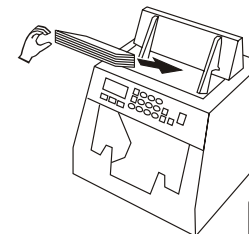

Place the notes to be counted onto the feed hopper.



The machine will automatically start, if **AUTO** is selected, or

or



you can choose to start it manually by pressing the **START** key.

3

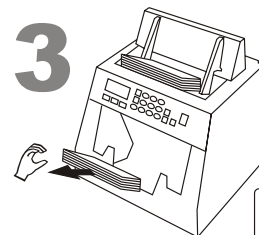

If the stacker limit is set at 100

If the number of notes to be counted is larger than the stacker limit, remove the notes from the stacker to continue to count. The machine will restart automatically if **AUTO** is selected.

count mode

4

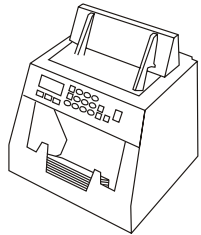

Every time a bundle is completed correctly, it is added to a running total which flashes automatically on the display.

5

Remove the notes from the stacker.

6



To clear the running total press the **CLEAR** key.



The maximum number of notes that can be counted is 99999. When this number is reached the machine will stop and flash 99999. Remove the notes from the stacker and press **CLEAR** to reset the total to 0.



Remove the notes from the stacker.

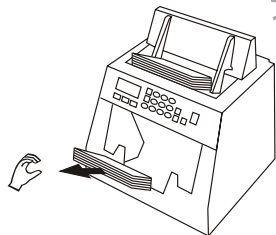

If the machine stops because of a 'degraded note' a rFEEd or ChEC message will be displayed. rFEEd indicates that the whole bundle should be fed again. If ChEC is displayed remove notes from the stacker and return only undamaged notes to the feeder.

If **AUTO** is selected, press **START** to clear the error message, the machine will restart automatically.

If **AUTO** is not selected, press **START** to clear the error message and press **START** to continue the count.

The count will be ignored and the display will revert to zero or the running **TOTAL**.

1600 value mode

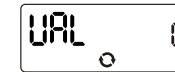
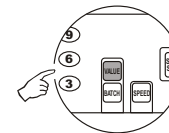

The value function of the machine allows you to 'Value' a bundle of notes by denomination, rather than to count the 'Quantity'. It will also dispense notes by denomination.

Pressing the **VALUE** key twice will switch the machine from counting mode to value count mode.

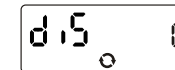

Pressing the **VALUE** key again will switch the machine to value dispense mode.

dEntr

1 Denomination entry

The denomination of the notes is manually entered by the operator. The machine will multiply all notes by the value entered.

count

1

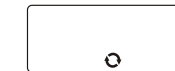
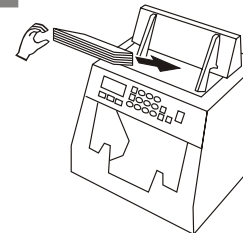

Place notes to be value counted in the hopper.

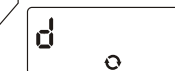

The denomination value of the last batch of notes will be shown.

2

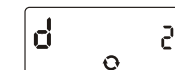

Key in the denomination of the notes to be counted.

NB If a note of a different denomination is hidden in a bundle it will be valued as the denomination selected.